

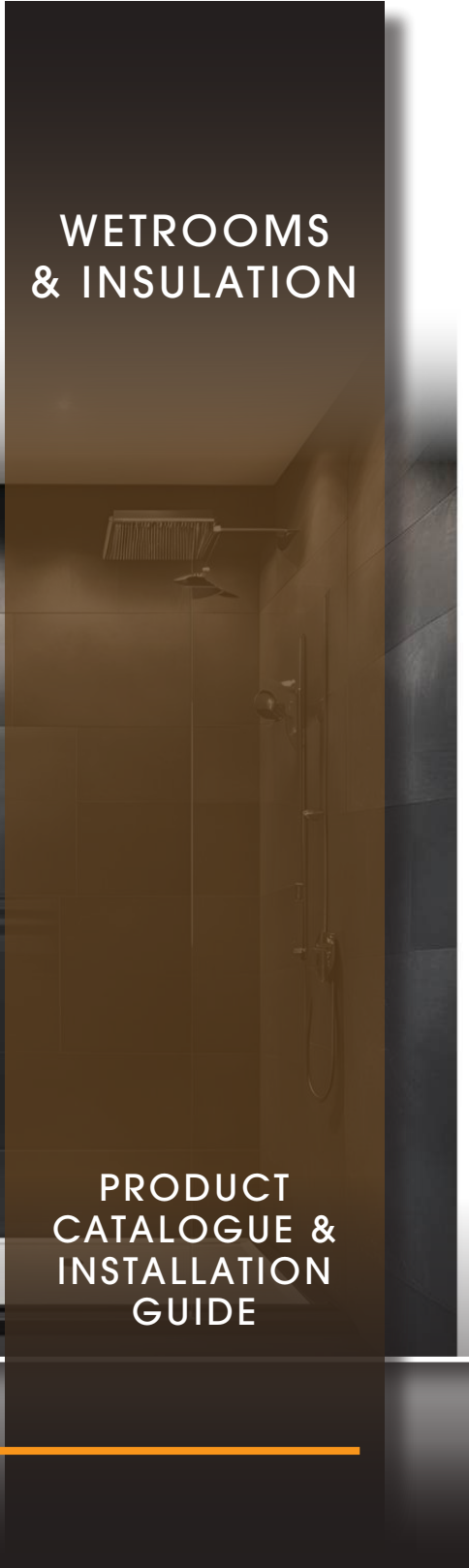

WETROOMS & INSULATION



PRODUCT
CATALOGUE &
INSTALLATION
GUIDE



ABOUT US

Thermopanel Products

Established in 2003, Thermopanel is a member of the Pedarson Group, committed to creating high quality wet room components at an attractive price. We produce a wide range of wet room products, including: tile backer insulation boards, waterproofing materials, walk-in shower trays, drains, underfloor heating and wet room accessories.

At Thermopanel we love a good-looking wet room and the brand was created from a desire to ensure that the growing trend for wet rooms is accessible to everyone. However, at Thermopanel we believe that it is what's underneath that truly counts. We encourage people to look beyond the facade and appreciate the importance of quality wet room foundations - because if it's not properly waterproofed then it's a damp room, not a wet room!

The benefits of installing a Thermopanel Wet Room Include...



100% WATERTIGHT

The Thermopanel system provides a solid waterproof foundation which will eliminate leaks and water damage.



A COMPLETE WET ROOM SOLUTION

Thermopanel produces all of the supplies and products needed to install a highly functional wet room.



CAN INCREASE PROPERTY VALUE

Studies have shown that homes that add a wet room as a second bathroom are of a higher value than comparable homes with only a traditional bathroom.



DIFFERENTIATION

Make your development stand out from competitors. Complete the look of the home and add prestige with a wet room installation.



QUALITY & VALUE

Thermopanel produces high quality products created with the user in mind.

CONTENTS

6 Tile Backer Board

10 Square Drain Shower Trays

16 Linear Drain Shower Trays

22 Tuffdeck Shower Trays

28 SMC Shower Trays

32 Shower Niches

36 Pipe Boxing

37 Bath Panels & Curved Boards

38 Tileable Shower Bench

40 Veloseal

41 Waterproofing & Tanking



THE FOUNDATION OF YOUR WETROOM

THERMOPANEL



①

**TILE BACKER
BOARDS**
PAGE 6

②

**TILE ON
SHOWER TRAYS**
PAGES 10 & 16

③

**TILE ON
BATH PANELS**
PAGE 37

④

**TILE ON
SHOWER BENCH**
PAGE 38



THERMOPANEL 25 YEAR WARRANTY
**THERMOPANEL
25 YEAR
WARRANTY**
THERMOPANEL 25 YEAR WARRANTY

3

THERMOPANEL

6

5

**TILE ON
SHOWER NICHES**
PAGE 32

6

**TILE ON
PIPE BOXING**
PAGE 36

7

**WATERPROOFING
JOINT TAPE**
PAGE 43

8

**WATERPROOFING
PIPE COLLARS**
PAGE 42

Create the foundation of your wet room with Thermopanel Tile Backer Boards

Thermopanel Tile Backer Boards are lightweight and easy to handle whilst providing superior waterproofing to your wet area.

Thermopanel Tile Backer boards are specifically designed for two primary purposes:

- As a first class heat insulation for underfloor heating systems.
- As a superior waterproof surface to fix wall or floor tiles.

- Tile backer boards are particularly suited to underfloor heating mats and under tile heating cable applications
- Will accept even the heaviest wall tiles, unlike plasterboard (correct installation method must be followed)
- Our boards will reduce the warm up time of the heating and reduce your electricity bill

- Excellent heat insulation with thermal conductivity value of 0.027 W/mK making them ideal for use as a thermal barrier with underfloor heating
- Tile backer boards are waterproof and dimensionally stable (unlike plywood)
- Excellent sound insulation: impact sound is greatly reduced

Tile Backer Board / Construction Board

Description

Code	Length/Width/Thickness
TP04	1250 x 600 x 4mm
TP06	1250 x 600 x 6mm
TP08	1250 x 600 x 8mm
TP10	1250 x 600 x 10mm
TP12	1250 x 600 x 12mm
TP15	1250 x 600 x 15mm
TP20	1250 x 600 x 20mm
TP30	1250 x 600 x 30mm
TP40	1250 x 600 x 40mm
TP50	1250 x 600 x 50mm

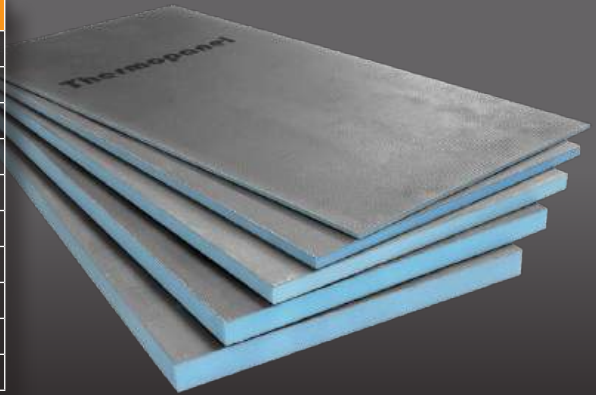

Wood Floor

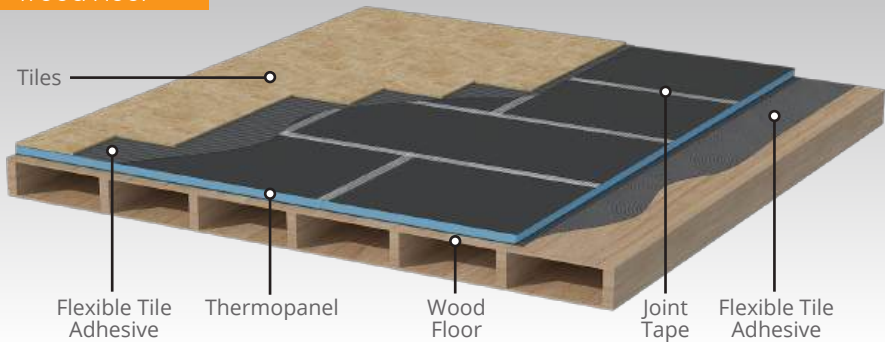

Concrete Floor

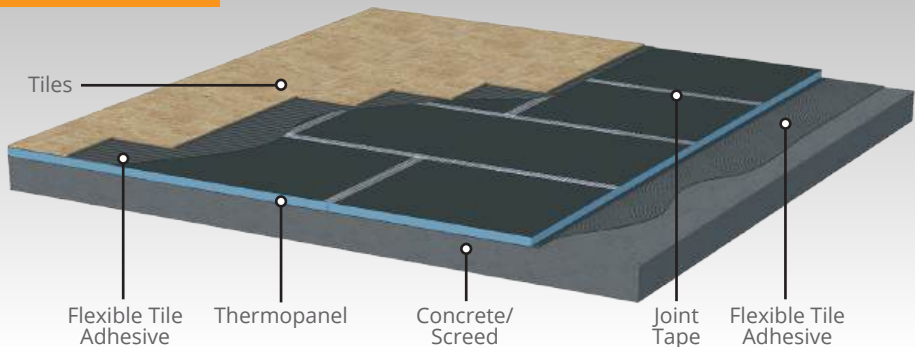

Installation Instructions For Tile Backer Boards

Timber Stud Walls

For walls made from stud, 10 or 12mm Thermopanel can be used for stud @ 300mm centres or 20mm Thermopanel if 600mm centres. Please ensure that all board edges are supported.



Fix Thermopanel to the studs using screws and Thermopanel washers (MSW36), the maximum spacing between fixings should be 300mm.

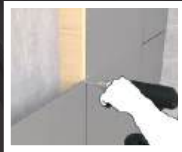

Solid Walls **Option 1 Screw Fixing**

Measure the Thermopanel and cut to size utilising a sharp knife or saw.



Wall plugs, screws and Thermopanel washers (MSW36) can be used at 300mm spacing to fix to a solid wall



Solid Walls **Option 2 Tile Adhesive**

A 5 to 8mm trowel is used to comb flexible tile adhesive over the whole surface of the Thermopanel.



Stagger the Thermopanel in brickwork fashion, pushing them firmly onto wall.



Solid Walls **Option 3 Drywall Fixing**

Apply Thermopanel Drywall Foam (TPDF) to Thermopanel, firstly around perimeter, then at (approx.) 300mm centres. Application to the board laid flat with its end against the wall is generally the quickest method for application to solid walls.



Allow the foam to cure for 4-5 minutes and then lever the board into position, then press firmly across the whole face of the board, starting at the top. Ensure the top and all edges receive as much pressure as the rest of the board.



Preparation for Tiles or Plaster

All joints should be taped using Thermopanel Joint Tape (IJT90) with the exception of wet areas where Thermopanel butyl tape (Btape) should be used. The wall can now be tiled.



Plastering. Seal the edges of the boards using Thermopanel adhesive/sealant (Thermofix) before applying the Thermopanel scrim tape (IJT90). Plaster can now be applied.



Floor Fixing - Tile Adhesive

Use a 5-8mm trowel to apply a layer of flexible tile adhesive on to the base floor.



Place the Thermopanel down on the adhesive and push firmly down.



Floor Fixing - Screws & Washers into Timber

Measure the Thermopanel and cut to size utilising a sharp knife or saw. Lay Thermopanel in the desired position.



Use screws and Thermopanel washers (MSW36) to fix the boards every 300mm to the wooden subfloor.



If further waterproofing is required, use Thermopanel adhesive / sealant (Thermofix) to seal the joints. Alternatively, in really wet areas use Thermopanel Butyl Tape (Btape)



Square Drain Shower Trays

Assembly Information

Thermopanel Shower Former Trays have been designed for wet rooms and walk in showers, providing a tileable shower base, avoiding the need for the traditional 'step-in' white acrylic tray. It is a lightweight flush floor panel with pre-made falls to drain, and is coated with a cementitious layer ready to receive a tiled surface.

NOTE:
Each side of the shower tray can be trimmed up to 50mm



FOR USE WITH
FLOOR TILES

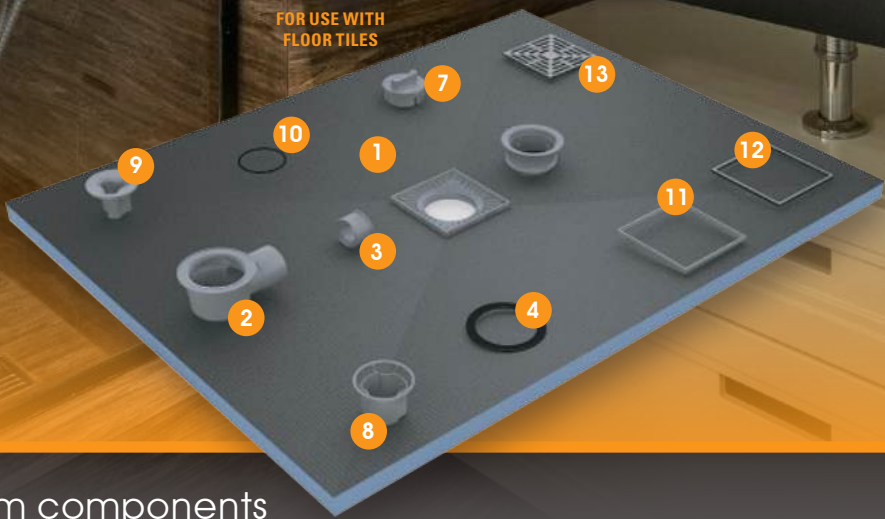

System components

- | | | |
|-------------------|-------------------|-------------------------|
| 1 Shower tray | 5 Plastic Support | 9 Inlet with seal |
| 2 Drain body | 6 Connection | 10 O-Ring |
| 3 50-40mm Reducer | 7 Key | 11 Riser Piece |
| 4 Rubber O-Ring | 8 Drain Basket | 12 Stainless Steel Edge |
| | | 13 Grate |

Specifications

	Part number	Description
Centre Drain	SF0808CEN	800 x 800 x 20mm
	SF0909CEN	900 x 900 x 20mm
	SF1010CEN	1000 x 1000 x 20mm
	SF1208CEN	1200 x 800 x 20mm
	SF1209CEN	1200 x 900 x 20mm
	SF1210CEN	1200 x 1000 x 20mm
	SF1212CEN	1200 x 1200 x 20mm
	SF1309CEN	1300 x 900 x 25mm
	SF1409CEN	1400 x 900 x 25mm
	SF1508CEN	1500 x 800 x 25mm
SF1509CEN	1500 x 900 x 25mm	
SF1809CEN	1800 x 900 x 25mm	

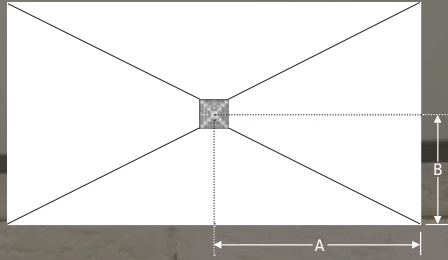

Position: Centre drain = $A=1/2$ length $B=1/2$ width

Corner Drain	SF0808COR	800 x 800 x 20mm
	SF0909COR	900 x 900 x 20mm
	SF1010COR	1000 x 1000 x 20mm
	SF1208COR	1200 x 800 x 20mm
	SF1209COR	1200 x 900 x 20mm
	SF1210COR	1200 x 1000 x 20mm
	SF1212COR	1200 x 1200 x 20mm
	SF1309COR	1300 x 900 x 25mm
SF1409COR	1400 x 900 x 25mm	

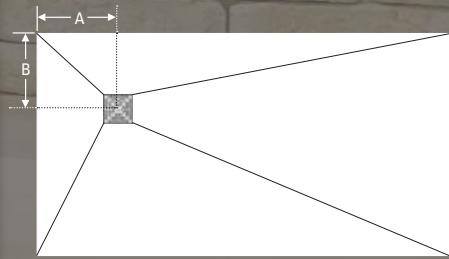

Position: Corner drain: $A=B+=280$ mm

Offset Drain	SF1010OFF	1000 x 1000 x 20mm
	SF1208OFF	1200 x 800 x 20mm
	SF1209OFF	1200 x 900 x 20mm
	SF1210OFF	1200 x 1000 x 20mm
	SF1212OFF	1200 x 1200 x 20mm
	SF1309OFF	1300 x 900 x 25mm
	SF1409OFF	1400 x 900 x 25mm
	SF1508OFF	1500 x 800 x 25mm
	SF1509OFF	1500 x 900 x 25mm
	SF1809OFF	1800 x 900 x 25mm

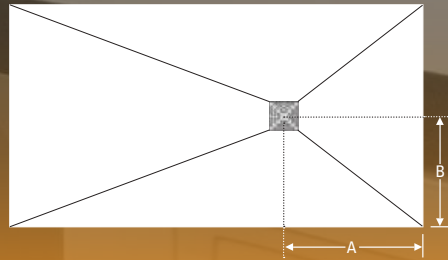

Position: Offset drain: $A=450$ mm $B=1/2$ width

Corner Drain Right	SF1208COR-R	1200 x 800 x 20mm
	SF1209COR-R	1200 x 900 x 20mm
	SF1210COR-R	1200 x 1000 x 20mm

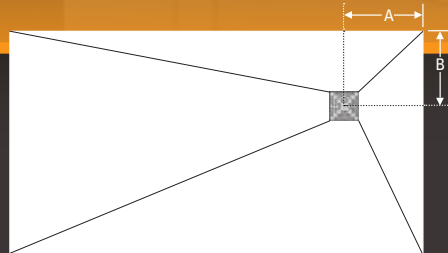

Position: Corner-right drain: $A=B+=280$ mm

Installation Instructions For Square Drain Shower Tray



Put shower tray in the correct position and mark around the tray, to establish which section of the floor boards needs to be removed, the tray can be recessed.



Once the floorboards are removed, measure and mark where your drain and waste pipe will be fitted. **Please note: The drain body needs to be split into 2 parts, the upper part fits to the underside of the former and the main body goes into the floor.**

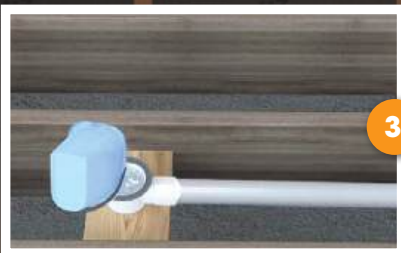

Cut a piece of plywood to support the drain for drain body, this should be 10mm higher than waste pipe. Connect the drain body to the waste pipe with solvent weld in the usual way. (Always check for leaks before final installation of shower tray).



Fix a batten below the top of the joists.



5

Once you are satisfied with the drainage, place plywood around the drain and fix in position.



6

Spread the adhesive evenly over the area where the shower tray is to be installed, being careful to clean away any adhesive on the rim of the trap.



7

Ensure that the surface is smooth & level.



8

Fix the shower tray into position. With a spirit level, check that the edges of the tray are level. You should also use waterproof tape to connect all joint and wall corners.



9

Seal all joints (both wall and floor) utilising special waterproof membrane / paste.



10

Seal all corners of shower area with inside corner membrane / paste.



11

Then set the O-ring on Inlet with Seal and put it in.



12

If there's height difference between tile and drain.

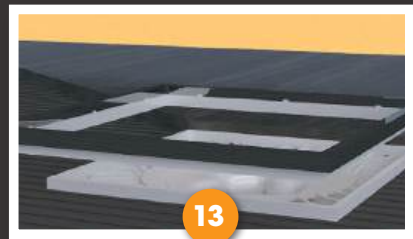

13

Use the riser piece to balance the height difference between tile and drain.



14

The shower base is finished and can be tiled.

Tips

In principle, you can use all types and sizes of tiles, special requirements for tiles and mosaic thickness to be <math><25\text{mm}</math>, and the size of the tiles and mosaic on the shower tray must be $=50 * 50\text{mm}</math>. Otherwise, you should consult the manufacturer.$

Installation Section Detail For Wooden Framework

Mokra Shower Tray Kit - Installation Height

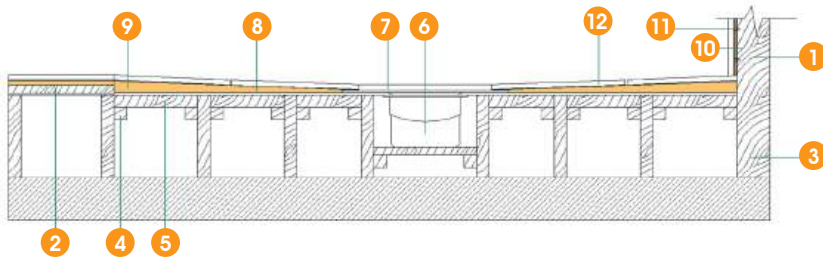

- | | | | | | |
|---|--------------------------|---|--|----|--------------------------|
| 1 | Wooden wall construction | 7 | Stainless steel grate | 10 | Backer board (6/10/20mm) |
| 2 | Floor board 18mm | 8 | Shower tray | 11 | Washer & crew |
| 3 | Floor joist | 9 | Sealing tape or Waterproofing membrane | 12 | Tiles |
| 4 | Support for ply board | | | | |
| 5 | Ply board 18mm | | | | |
| 6 | Shower drain body | | | | |

Installation Section Detail For Concrete Floor

Mokra Shower Tray Kit - Installation Height

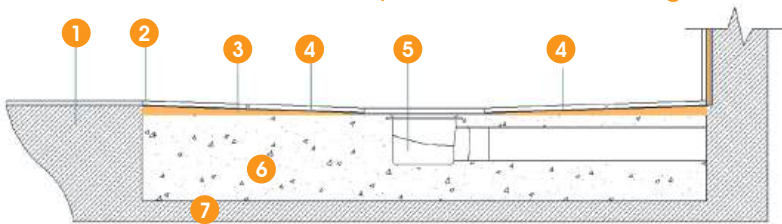

- | | | | | | |
|---|-------------------------|---|-------------|---|------------------|
| 1 | Screed | 4 | Slope | 6 | Levelling screed |
| 2 | Waterproof sealing tape | 5 | Floor drain | 7 | Concrete floor |
| 3 | Shower tray | | | | |

Linear Drain Shower Tray

Assembly Information

Our Linear shower tray kit consists of a shower tray and a drainage system. Both components are coordinated with each other and form one unit.



NOTE:
Each side of the shower tray
can be trimmed up to 50mm

System components

- | | | | |
|----|---|-----|---|
| 1 | Drain Body | 7b | Short Or Long Screw
For Height Adjustment Spacer
(Please use these screws according
to your requirement) |
| 2 | Dip-tube | 8 | Connection |
| 3 | O Ring | 9 | Plastic support 600mm length |
| 4 | Drain Basket | 10a | Stainless Steel Support 600mm length |
| 5 | 50-40mm Reducer | 10b | Stainless Steel Grate 600mm length |
| 6 | Height Adjustment
Spacer (thickness 1.5mm) | | |
| 7a | Screw For Connection
(M5.5*29mm) | | |

Specifications

Linear	Dimensions					
Part no	X	Y	A	B	C	D
SF0909LIN	900	900	600	150	200	70
SF1010LIN	1000	1000	600	150	200	70
SF1209LIN	1200	900	600	150	200	70
SF1212LIN	1200	1200	600	600	200	70
SF1509LIN	1500	900	600	150	200	70
SF1809LIN	1800	900	600	150	200	70

Side	Dimensions					
Part no	X	Y	A	B	C	D
SF1209LIN90	1200	900	600	300	200	70
SF1509LIN90	1500	900	600	450	200	70
SF1809LIN90	1800	900	600	600	200	70

Centre	Dimensions					
Part no	X	Y	A	B	C	D
SF1209LICEN	1200	900	612	600	450	160
SF1509LINCEN	1500	900	612	750	450	160
SF1809LINCEN	1800	900	612	900	450	160

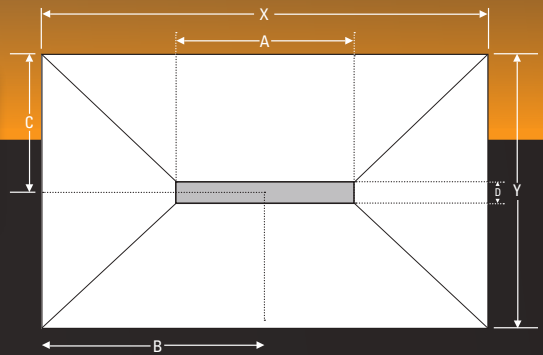
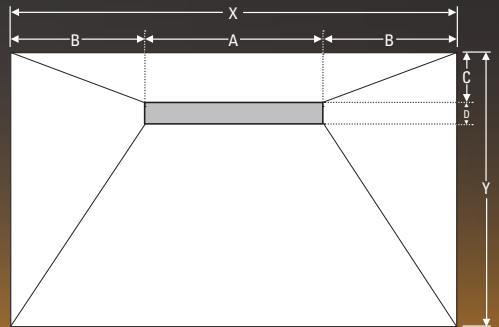
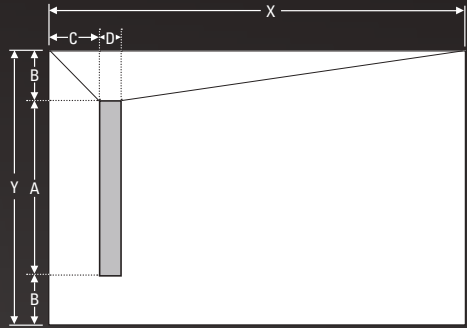

Grate Options

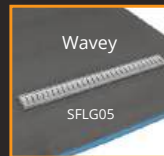
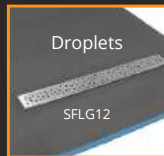

Installation Instructions For Linear Drain Shower Trays



1

Put shower tray in the correct position and mark around the tray, to establish which section of the floor boards needs to be removed, the tray can be recessed.



2

Once the floorboards are removed, measure and mark where your drain and waste pipe will be fitted. **Please note: The drain body needs to be split into 2 parts, the upper part fits to the underside of the former and the main body goes into the floor.**

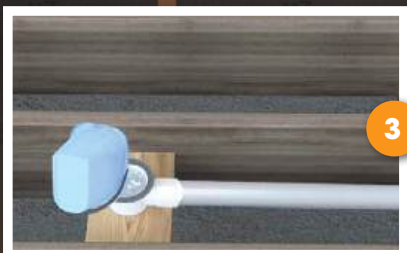

3

Cut a piece of plywood to support the drain for drain body, this should be 10mm higher than waste pipe. Connect the drain body to the waste pipe with solvent weld in the usual way. (Always check for leaks before final installation of shower tray).



4

Fix a batten below the top of the joists.



5

Once you are satisfied with the drainage, place plywood around the drain and fix in position.



6

Spread the adhesive evenly over the area where the shower tray is to be installed, being careful to clean away any adhesive on the rim of the trap.



7

Ensure that the surface is smooth & level.



8

Seal all joints (both wall and floor) utilising special waterproof membrane / paste.



9

Seal all corners of shower area with inside corner membrane / paste.



10

Assemble other drain components

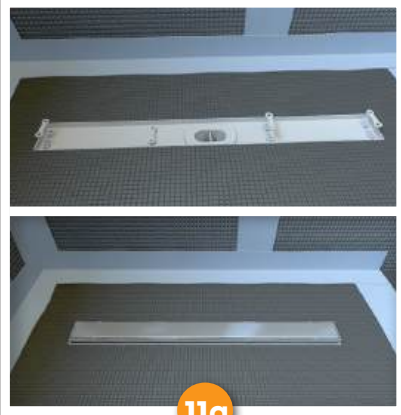

11a

If you're not using a tile on grate, adjust the height of the stainless steel support utilising the height adjustment spacers, each space will increase the height by 1.5mm.

Depending on the number of spacers used, use either the long or short screws to fix the stainless steel support to the tray



11b

If you're using a tile on grate, the height of the stainless steel support can be adjusted utilising the height adjustment spacers, but the inner height of the tile on the grate is fixed (13mm). Please ensure that you use suitable tiles for the grate and the shower tray.



12

The shower base is now finished and can be tiled.

Tips

In principle, you can use all types and sizes of tiles, special requirements for tiles and mosaic thickness to be <25mm, and the size of the tiles and mosaic on the shower tray must be =50 * 50mm. Otherwise, you should consult the manufacturer.

Installation Section Detail For Wooden Floor

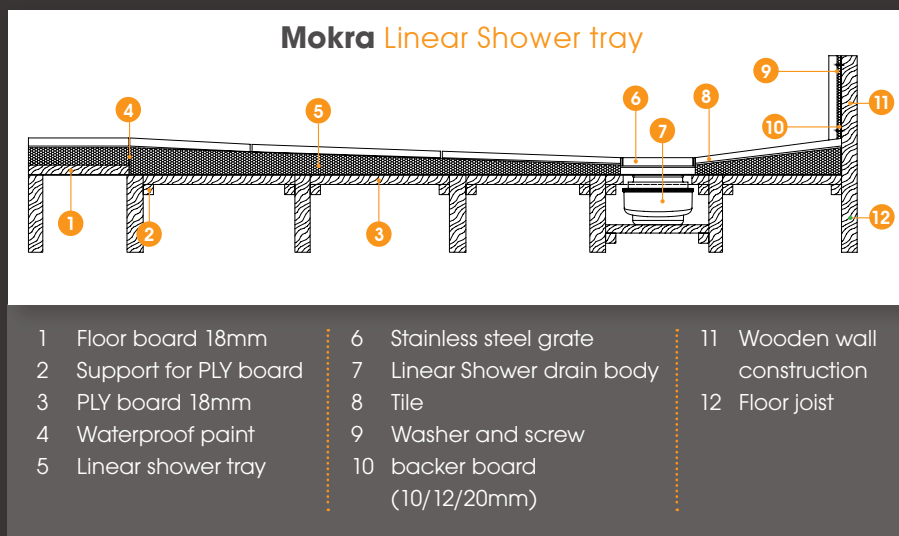

Installation Section Detail For Concrete Floor

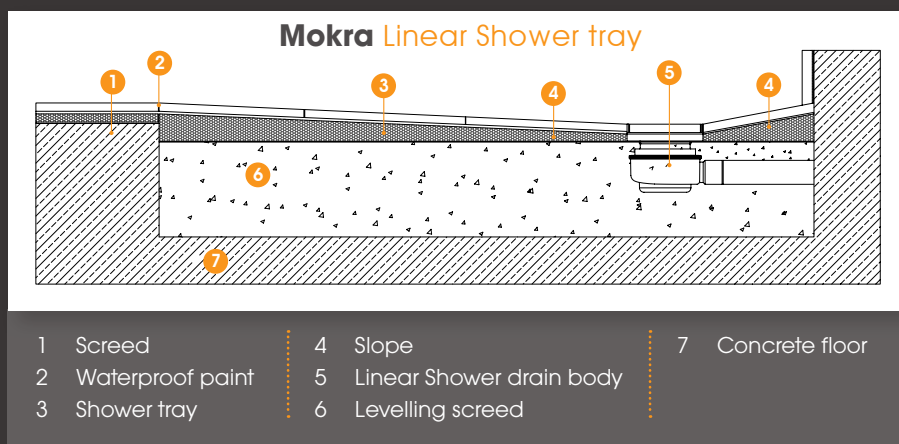

THERMOPANEL

Tuffdeck

Thermopanel Tuffdeck shower trays provide excellent strength and durability, allowing you to create a walk-in wetroom shower area to be concealed beneath vinyl flooring once installed.



FOR USE WITH VINYL & TILE FLOOR COVERINGS

Manufactured using the SMC process from a combination of resin and fibreglass to form a strong and consistent floor former.

Available sizes

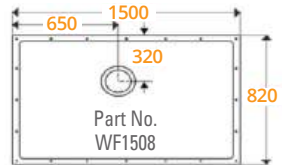
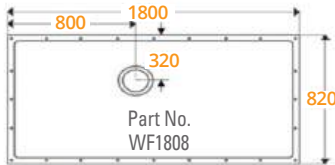
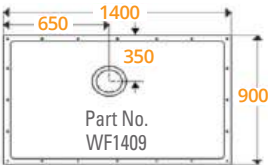
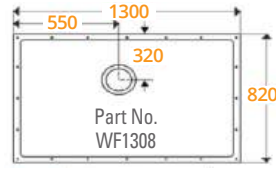
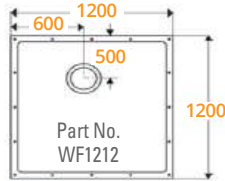
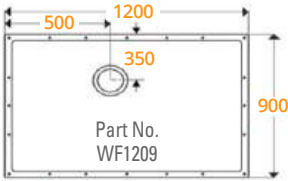
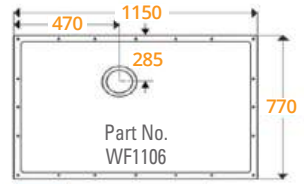
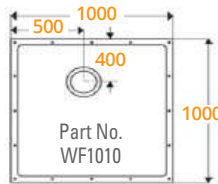
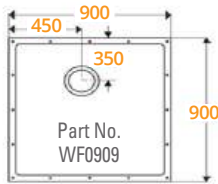

Available Drains



Vinyl Shower Drain
(Part WP04)



Vinyl Waste Shower Drain
(Stainless Steel)
(Part 08GT52-R)



Tile Shower Drain
(Part TSG52)



Features

- Easy to install for both trade professionals and DIY enthusiasts
- Tested to withstand up to 100 Stone / 635kg
- Pre-formed semi-drilled fixing points for secure installation
- Designed with a textured top surface for excellent adhesion of vinyl flooring
- Suitable for timber & screeded floors
- Crafted with a gridded underside design for setting into a concrete or screed base, eliminating slippage when installing
- Ideal for those wanting a large-level access shower space
- Trays are trimmable and can be cut in any position using a circular saw or jigsaw
- Accessible for wheelchair uses
- Offset waste positions available to avoid joists
- Durable and waterproof
- Available in a range of sizes

Part Number	Description	Width (mm)	Length (mm)	Thickness (mm)
WF0909	900x900mm Tuffdeck Wetroom Former without waste	900	900	22
WF1010	1000x1000mm Tuffdeck Wetroom Former without waste	1000	1000	22
WF1106	1150x770mm Tuffdeck Wetroom Former without waste	1200	1200	22
WF1209	1200x900mm Tuffdeck Wetroom Former without waste	1200	750	22
WF1212	1200x1200mm Tuffdeck Wetroom Former without waste	1300	800	22
WF1308	1300x820mm Tuffdeck Wetroom Former without waste	1400	900	22
WF1409	1400x900mm Tuffdeck Wetroom Former without waste	1500	1000	22
WF1508	1500x820mm Tuffdeck Wetroom Former without waste	1500	1200	22
WF1808	1800x820mm Tuffdeck Wetroom Former without waste	1500	820	22

Installation Instructions Concrete & Solid Floor

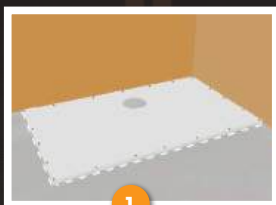

1
Locate Tuffdeck in the corner to which it is going to be finally positioned & mark lines around the outer edge. If cutting to size use a circular saw or jigsaw.

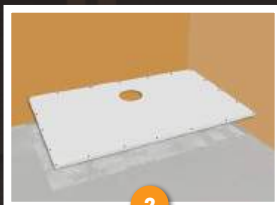

2
Excavate the floor within the marked area to a sufficient depth of 24mm to accept Tuffdeck.

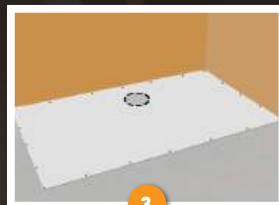

3
Ensure Tuffdeck fits neatly into the recess. Mark shower trap position.



4
Remove Tuffdeck. Decide upon the position of the waste pipe knocking out a hole in the adjacent wall if required. It will be necessary to remove an area to sufficient depth under the outlet position to accommodate the shower trap. (Approximate trap depth 95mm x 110mm wide). The trap must be fully supported underneath with a self levelling screed mix.

METHOD 1

(As shown in points 5 & 5a)
Set the trap body into the floor. Place the trap flange into Tuffdeck ensuring it finishes flush with, or just below the surface on which the sheet flooring is to be laid.

Attach flange to the trap body using the 4 bolts provided, ensure the rubber seal is in place. Secure flange to Tuffdeck, there are 4 off csk indentations in the flange to assist with this. Connect trap to waste pipe for outflow drain.

METHOD 2

Fully assemble the trap to Tuffdeck (as described above) before placing in position, also attaching a length of pipework ready for connection to the waste / soil pipe. If you are using a pump, the fitting of the shallower pumped trap is the same as described above.

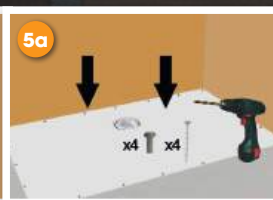
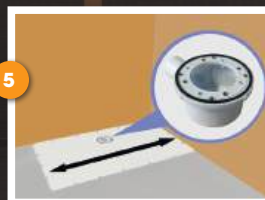

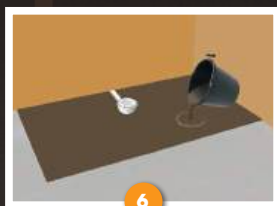

6

Apply a self levelling screed mix to cover all of the proposed area. This will ensure Tuffdeck is fully supported. Caution! Ensure the void around the trap body is also filled. DO NOT rely solely on support from under the flange.



7

Circular ribbed underside allows Tuffdeck to settle on a cement or screed base eliminating slippage during installation. Carefully place Tuffdeck into position. Checking levels in both directions, gently tap Tuffdeck down until level on all 4 sides. It may be necessary to add more self levelling screed, do this by slightly lifting Tuffdeck & pouring in the screed.

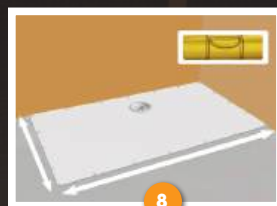

8

It is important that Tuffdeck is level on all 4 sides when fitted & then left to set. **TIP:** Filling the Tuffdeck / floor joint & the screw ports using a resin car body filler or similar will form a strong bond between Tuffdeck & the bathroom floor as well as prevent indentations appearing in the floor covering.



9

At this stage you will now be ready to bond into position the relevant coverings & floor coverings.

NOTE:
Bond vinyl sheet flooring to the floor using a 2 part water resistant adhesive. All flooring should be installed in accordance with the manufacturers guidelines.



10

Once the floor covering is laid, screw into position the trap clamping ring using the bolts provided, ensuring the inner cup & dip tube can still be removed. Fit the shower traps push on cover plate.

Installation Instructions Wooden Floors



1

Locate Tuffdeck in the corner to which it is going to be finally positioned and mark lines around the outer edge. If cutting to size use a circular saw or jigsaw.



2

Remove the floor within the marked area to a depth of 18mm to accept Tuffdeck. Ensure the joists provide a secure and flat surface for the Tuffdeck. It may be necessary to use packing on the joists to ensure the Tuffdeck is level.

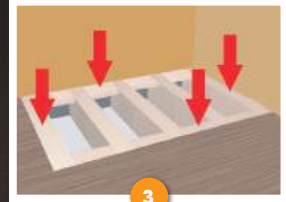

3

Use noggins to support all outer edges of the Tuffdeck as shown above.

IT IS NOT NECESSARY TO USE ADDITIONAL NOGGINS AROUND THE WASTE POSITION.

NOTE: If the floorboards are 18mm thick you would need 6mm plywood to make the Tuffdeck and floor absolutely level in order to apply your floor covering.



4

Connect the trap body to your outlet pipework, position between joists and centrally beneath the hole in the Tuffdeck. Ensure the trap is fully supported underneath.

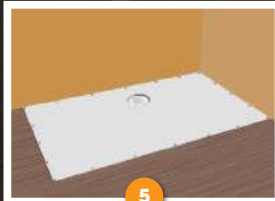

5

Place the Tuffdeck in position.



6

Attach flange to the trap body using the 4 bolts provided, ensuring that the rubber seal is in place. Secure flange to Tuffdeck, there are 4 countersunk indentations in the flange to assist with this.

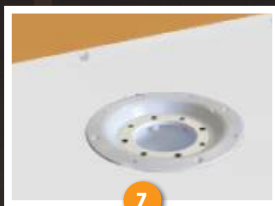

7

Also ensure that the flange on the trap body is level with, or slightly below the Tuffdeck once in its correct position and that the rubber seal is in place.

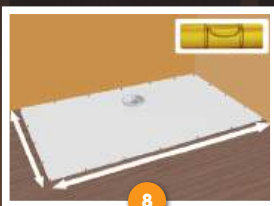

8

Ensure that the Tuffdeck is well supported and completely level.

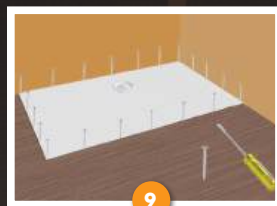

9

Use the longer screws provided to secure the Tuffdeck to the floor joists. Ensure Tuffdeck is secured along all 4 edges to eliminate any movement. **IT IS NOT NECESSARY TO PILOT DRILL THROUGH THE SCREW PORTS.**

TIP: Fill the joint, using a resin car body filler or similar to form a strong bond between the Tuffdeck & the floor.



10

At this stage you will now be ready to bond into position the relevant covings and floor coverings.

NOTE:

Bond vinyl sheet flooring to the floor using a 2 part water resistant adhesive. All flooring should be installed in accordance with the manufacturers guidelines.



11

Once the floor coving is laid, screw into position the traps clamping ring using the bolts provided ensuring the inner cup and dip tube can still be removed. Fit the shower traps push on cover plate.

SMC Shower Trays

With a modern, low-profile design and a clean appearance, this shower tray will make a great addition to any bathroom.

The bathroom base is characterised by a low threshold for easy entry and exit. The shower base is hard-wearing and reinforced for durability.

The shower tray features a slip-resistant slate stone surface finish and is made from scratch and stain resistant SMC. This means the tray will withstand years of use, and also makes for easy cleaning.

Features

- Lightweight & durable
- Low threshold
- Standard dia. 9 cm drain opening (drain not included)
- Easy to clean
- Maximum stability

Material: SMC (Sheet Moulding Compound) with resin, fiberglass and stone powder

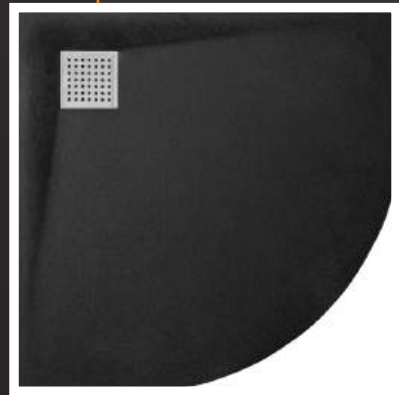
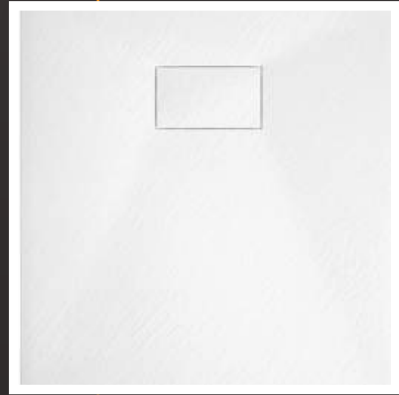

Available sizes

Part no	Dimensions				
	X	Y	A	B	C
ST0808	800	800	200	124	202
ST0909	900	900	200	124	202
ST1007	1000	700	200	124	202
ST1008	1000	800	200	124	202
ST1207	1200	700	200	124	202
ST1208	1200	800	200	124	202
ST1209	1200	900	200	124	202
ST1407	1400	700	350	124	202
ST1408	1400	800	200	124	202
ST1409	1409	900	200	124	202
ST1507	1500	700	350	124	202
ST1508	1500	800	216	124	202
ST1509	1500	900	216	124	202
ST1607	1600	700	350	124	202
ST1608	1600	800	216	124	202
ST1609	1600	900	216	124	216
ST1707	1700	700	350	124	202
ST1708	1700	800	350	124	202
ST1709	1700	900	350	124	202

Part no	Dimensions						
	X	Y	A	B	C	D	R
STR0808	800	800	200	120	120	200	549
STR0909	900	900	200	120	120	200	550

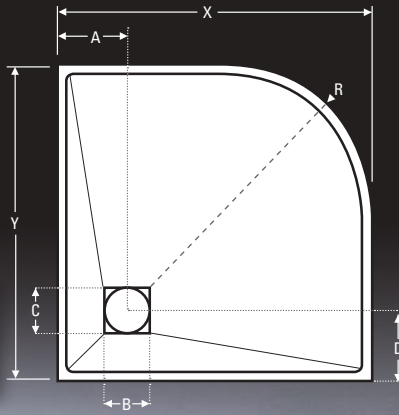
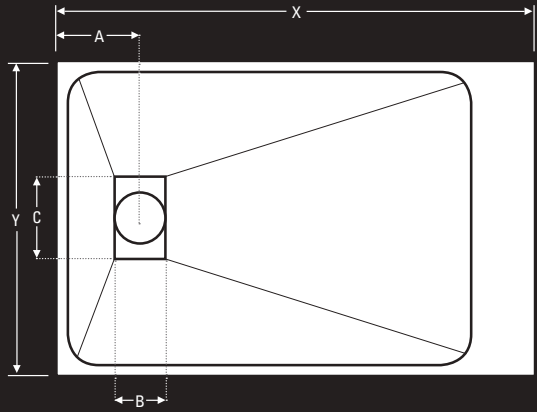

Drain Cover Options



Solid
(Part CP05)

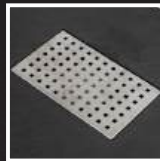

Stainless Steel
(Part CP01)



Holes
(Part CP05B)

Installation Instructions Solid & Concrete Flooring



Position the tray over the desired location for the shower tight against plaster finish on the back walls in order to provide a seal. Mark around the waste area and the tray edges on the floor. Plan the waste outlet position.



Remove the tray and start to remove any tiling or vinyl flooring to expose the concrete flooring. Cut along marked area taking care not to cut through any pipework or any electrical wiring which may be buried below.

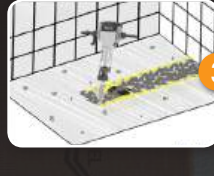

Dig out the floor area and remove any hard material to allow for the tray, waste and outlet pipe. Remove the flooring to allow the installation of the waste and the outlet pipe with a fall of at least 1 in 40. When using the low depth waste, dig out approximately 60mm (2 1/2") depth needed under the waste position to allow installation. Connect the waste to the outlet pipe.



Test the waste trap drainage and for leakages by pouring water into the waste trap before fitting

to the tray. Sand and cement should be used to raise the tray to the finished floor height and ensure this is level. Allow this mix to set. The tray should be bedded onto flexible adhesive, applied to the subscreed to hold the tray firmly in position and level. Do not dot and dab. Foam should not be used as a load bearing support as it will break down under repeated product use.

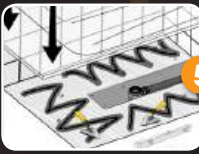

Lower the tray over the waste and check the waste drain position and test that all 4 edges of the tray are level. The edges of the tray must finish flush and level with the top of the finished floor covering.

6 Connect the waste drain to the tray using the clamping ring. See separate waste instructions. The waste cover should now be secured in place and protected for the rest of the installation.

The flooring should be laid up to the edge of the tray and sealed with silicone sealant. The walls should be covered with the waterproof wall covering and then sealed to the tray with silicone sealant.

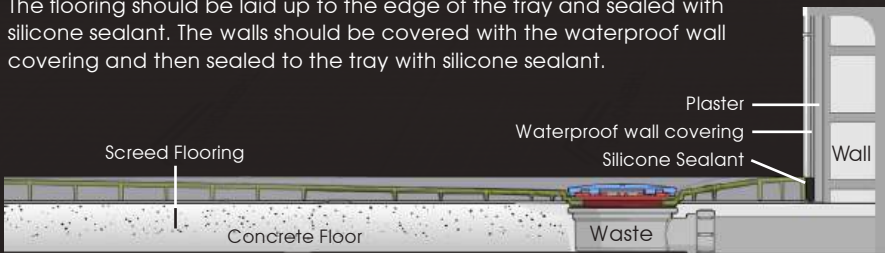

Installation Instructions

Wooden Flooring



1

Position the tray over the desired location for the shower and mark around the edge of the shower former.



2

Cut into the flooring, taking care not to cut through supporting joists or any plumbing or electrical wiring.



3

Carefully remove the floor boards. Locate the waste outlet pipe.

Additional noggins or joists must be used on all edges and between joists centres at a minimum of 350mm.



4

The waste area must be supported with additional noggins 220 mm around the waste.

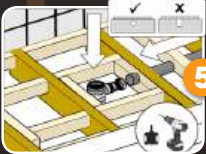

5

Do not cut into the joists, always drill through when installing the waste drain trap and waste outlet pipe.

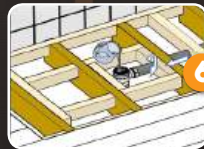

6

Water test the waste drain trap for flow and for any leaks and ensure that the rubber seals are in place.



7

Bed the tray on flexible adhesive on the joists and check it's level and supported on all 4 sides. The waste clamping ring should now be fitted to secure and seal the waste to the tray. Install the waste trap to the tray, see separate waste instructions. The waste cover should now be secured in place. Re-check tray is level and test for water drainage efficiency of tray. Vinyl floor covering or tiles should finish flush and up to the tray as shown below. The flooring should be laid up to the edge of the tray and sealed with silicone sealant. The walls should be covered with the waterproof wall covering and then sealed to the tray with silicone sealant.

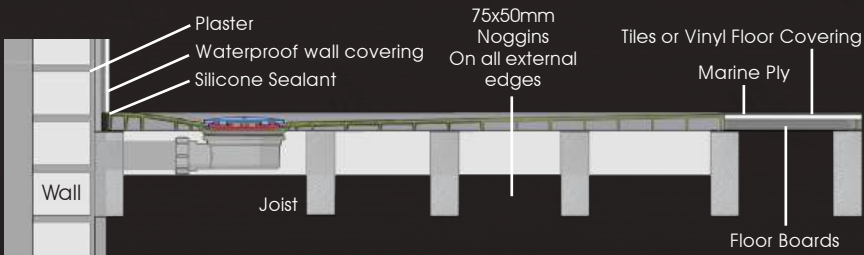

Tileable XPS Shower Niches

Thermopanel Shower Niches are made out of XPS Foam, coated with a polymer cement mortar and a fibreglass mesh which provides a sturdy tileable surface for you to tile onto. In combination with Thermopanel Tile Backer Boards, creating your own bathroom or wetroom has never been easier.

They comprise of an extruded polystyrene core coated on either side with a thin robust layer of fibreglass reinforced polymer concrete and coated with a waterproof membrane paint.

Thermopanel Shower Niches are fixed to a timber frame, so that the front of the Niche is flush with the Thermopanel construction boards on the wall. The joints between the Niche and the construction boards are sealed together with Waterproofing Sealing Tape (see page 41).

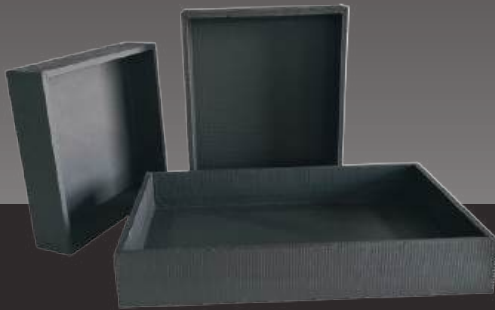
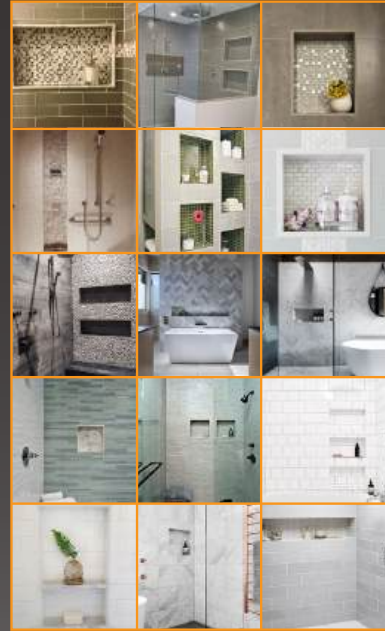

Features

- Completely waterproof
- Provides thermal insulation
- Ready to tile
- Lightweight and easy to work with.
- Made with 12.5mm thick board and fit wall cavities 100mm or deeper
- Comes already constructed which guarantees conformity and size

Part Number	Description	Width (mm)	Height (mm)	Depth (mm)
TPN350240	Tileable Shower Niche	350	240	100
TPN350350	Tileable Shower Niche	350	350	100
TPN350420	Tileable Shower Niche	350	420	100
TPN900250	Tileable Shower Niche	900	250	100

Tileable EPS Shower Niches

Thermopanel EPS Niche is constructed of lightweight high-density expanded polystyrene with a waterproof finish and ready to tile.

Thermopanel EPS fabricated niches are a one piece construction and waterproof. Guaranteed to never rot, degrade or leak. Their insulative factor does not promote condensation in the wall cavity. The perfect fit for all your shower necessities, our niches install quickly and safely and integrate flush into the wall panel assembly.

Features

- Lightweight & durable
- Easy to transport, handle and adjust during installation
- Installed in minutes
- Waterproof and ready to tile
- Multiple design options and sizes available

Part Number	Description	Width (mm)	Height (mm)	Depth (mm)	Internal (mm)
TPN235235F	Tileable Shower Niche	235	235	100	200x200
TPN360360F	Tileable Shower Niche	360	360	100	300x300
TPN360565F	Tileable Shower Niche	360	565	100	300x510
TPN235565F/2	Tileable Shower Niche	235	565	100	200x150 + 200x300
TPN360565F/2	Tileable Shower Niche	360	565	100	300x150 + 300x300



Stainless Steel Shower Niches

Thermopanel Shower Niches are low cost, easily installed and completely waterproof. Designed to provide extra space for small shower items.

Thermopanel introduces its range of Stainless Steel Shower Niches, a stylish and practical addition that infuses a contemporary touch of elegance into your bathroom. Each niche, flaunting a sleek finish, is designed to offer convenient storage for all your shower necessities.

They complement a variety of bathroom and wetroom designs, making them a flexible choice for any bathroom upgrade or renovation project.

Each niche is constructed from top-tier Stainless Steel, designed to endure. They not only showcase an appealing look but also resist rust and corrosion, promising long-lasting performance for the foreseeable future. The sleek design effortlessly blends with a broad spectrum of bathroom styles, making them a flexible choice for any bathroom project.



Stainless Steel Recess Shower Niche - Matte Black

	Code	Size (mm)
(A)	SSN3030B1	305 x 305 x 103
(B)	SSN6030B1	610 x 305 x 103
(C)	SSN3060B1	305 x 610 x 103 (1x shelf)
(D)	SSN2090B1	915 x 204 x 103 (2x shelves)



Stainless Steel Recess Shower Niche - Noir Black

	Code	Size (mm)
(A)	SSN3030B2	305 x 305 x 103
(B)	SSN6030B2	610 x 305 x 103
(C)	SSN3060B2	305 x 610 x 103 (1x shelf)
(D)	SSN2090B2	915 x 204 x 103 (2x shelves)

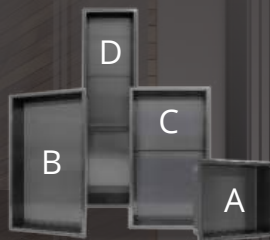

Stainless Steel Recess Shower Niche

	Code	Size (mm)
(A)	SSN3030S	305 x 305 x 103
(B)	SSN6030S	610 x 305 x 103
(C)	SSN3060S	305 x 610 x 103 (1x shelf)
(D)	SSN2090S	915 x 204 x 103 (2x shelves)



Stainless Steel Recess Shower Niche - White

	Code	Size (mm)
(A)	SSN3030W	305 x 305 x 103
(B)	SSN6030W	610 x 305 x 103
(C)	SSN3060W	305 x 610 x 103 (1x shelf)
(D)	SSN2090W	915 x 204 x 103 (2x shelves)



Pipe Boxing

The Solution to Hide Unsightly Pipework

Specially designed to enable easy, fast and clean boxing-in of exposed pipe work. The Thermopanel pipe boxings are completely waterproof so they are suitable for shower and wet rooms.

The Pre-fabricated boards are 20 mm thick. Made from 100% HCFC-FREE XPS hard foam, reinforced with fibreglass mesh on both sides and coated with polymer-modified mortar. The boards are 100% waterproof and remain fully functional.

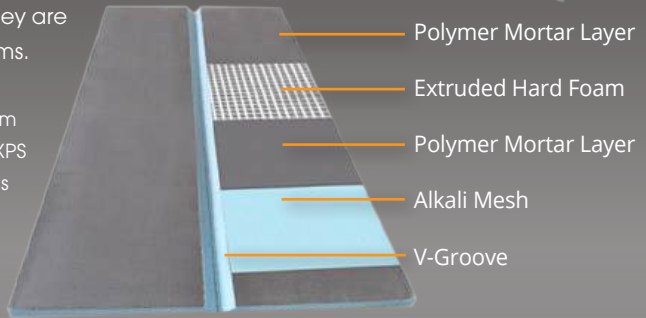
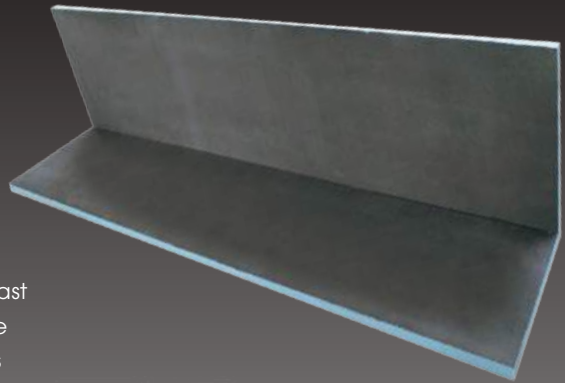

Features

- Can be either tiled or plastered
- Fast and efficient way to box in pipes prior to tiling or plastering
- Greatly reduces installation time
- Provides a much better tiling surface than timber
- Reduces the need to plasterboard timber when applying render
- Waterproof and stable in a moist environment
- Can be used to create designs in a bathroom rather than simply covering unsightly features
- Easy and cost effective method for creating tiled columns and rounded corner panels

Part Number	Description	Thickness (mm)	Width (mm)	Height (mm)	Depth (mm)
TP150	Pipe Boxing Panel – 'L'	20	150	150	1250
TP200	Pipe Boxing Panel – 'L'	20	200	200	1250
TP300	Pipe Boxing Panel – 'L'	20	300	300	1250

Bath Panels

Perfect for tiling around your bath with tiles matching the walls and/or floor, Thermopanel bath panels offer the best solution.

The panels just need to be cut to the correct length, positioned and height adjusted using the integral feet. You're now ready to tile!

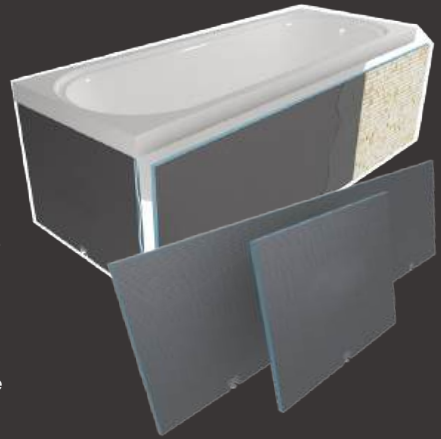

Part Number	Description	Length (mm)	Width (mm)	Depth (mm)
TPBP1	Tileable Side Bath Panel with 2 adjustable Feet	2100	600	30
TPBP2	Tileable End Bath Panel with 2 adjustable Feet	1850	600	30
TPBP3	Tileable Bath Panel with 1 adjustable foot	770	600	30

Curved Boards

Thermopanel Pre-Slit Curved Boards are the perfect solution for the fast creation of curved walls, curved bathroom panels, moulded tiled seats and P-shaped baths.

The boards are exceptionally easy to work with, easy to cut and shape with excellent tile adhesion and waterproofing properties.

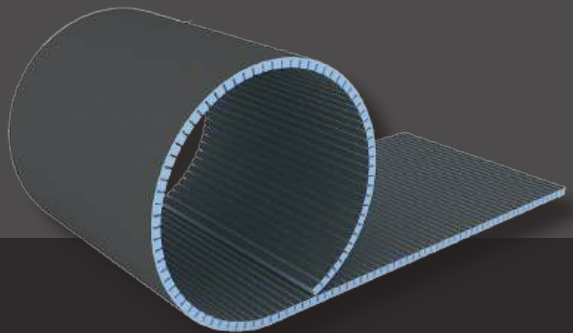

Part Number	Description	Length (mm)	Width(mm)	Depth (mm)
TP20CB	Curved Construction board	1250	600	20

Tileable Shower Bench

Shower Bench Components

- 1 Top seat panel
- 2 3x Supporting Panels
- 3 Front Cover Panel

Thermopanel Tileable Shower Seats allow you to create a comfortable sitting area in large showers, bathrooms, wetrooms, saunas or even steam rooms to provide a luxury shower experience. The kit comprises of the main bench seat section, 3 support legs and a front panel manufactured from Thermopanel XPS foam which allows you to cut down the bench to fit your requirements and best suit your space.

Part Number	Description	Length (mm)	Width(mm)	Height (mm)
SB12500-KIT	Tileable Shower Bench	1200	480	500

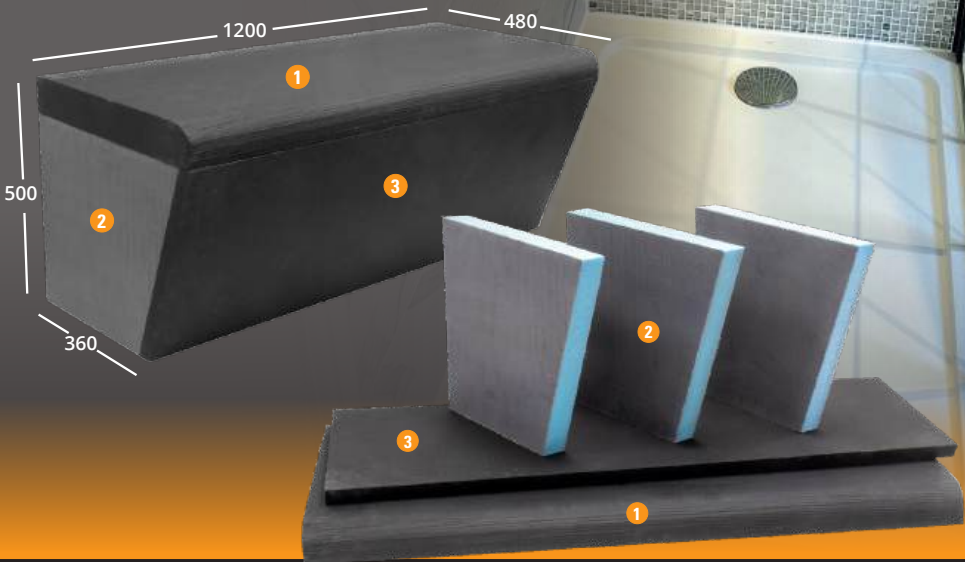

Installation

Cut the bench down to the required size, if required. Glue the individual components together with a suitable adhesive and use the stainless steel screws provided to secure the panels to each other to prevent movement while the adhesive sets.



9x - 6.0 x 130mm
Stainless Steel Screws
25mm in from edges

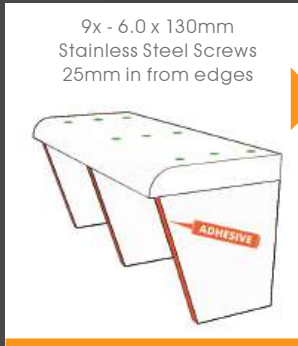

9x - 6.0 x 70mm
Stainless Steel Screws
25mm in from edges



The bench can be used inside heated buildings, particularly in areas with a high level of humidity such as bathrooms, steam baths and spas. Temperatures should not exceed 75°C.

Tiling / Plastering

The top of the bench must be tiled to ensure an adequate load distribution. All other surfaces can be covered with tiles, plaster or cladding.

Please seek the adhesive manufacturer's recommendations for use in areas with high levels of heat.

Electric Underfloor Heating

Thermopanel Benches can be used with electric underfloor heating. The heating core must not exceed temperatures of 75°C. Please follow the manufacturers instructions for installation.

Self Adhesive Sealing System

The VeloSeal self-adhesive sealing system is a high-speed solution for sealing bathrooms, wet rooms, and shower areas.

The system is designed to provide quick installation, in half the time it takes for standard tanking kit installs. Unlike traditional adhesive solutions, there is no need to mix and apply adhesive, making the installation process much faster and cleaner. VeloSeal is for use in conjunction with tiled and slab flooring, providing excellent performance and durability. VeloSeal is made with a Polyethylene and fleece webbing surface which provides an excellent surface to tile onto, combined with a self-adhesive backing.

Why Choose VeloSeal?

- Saves time, money and mess
- No need for tile adhesives
- Prevents the introduction of extra moisture during installation
- No drying times
- No need for the laborious task of cleaning work materials



Code	Size
VT5	5m x 80mm Tape
VT10	10m x 80mm Tape
VT30	30m x 80mm Tape
VS-INT	Internal Corner
VS-EXT	External Corner
VS5	5m x 1m Membrane Roll
VS10	10m x 1m Membrane Roll
VS30	30m x 1m Membrane Roll



VT5 / 10 / 30

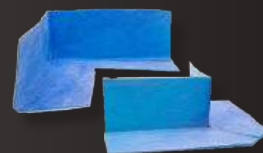

VS-INT / EXT

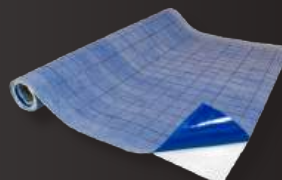

VS5 / 10 / 30

Waterproofing



When building a wetroom or bathroom it is important to properly waterproof the room. Without adequate waterproofing you can run into a magnitude of problems from mould to dampness and even flooding that can cause severe damage to your home.

Our range of Uncoupling / Decoupling matting reduces the risk and will make sure that tiles do not crack.

As the floor moves the material will decouple from the waterproof layer of the mat, allowing the floor to move but not the tiles on top of it – preventing cracking.

AFPROMAT Decoupling Membrane

Part Number	Size
AFPROMAT5	5m x 1m
AFPROMAT10	10m x 1m
AFPROMAT30	30m x 1m

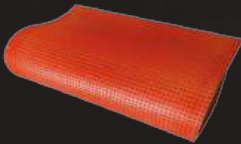

DCMF Fleece Decoupling Membrane

Part Number	Size
DCMF5	5m x 1m
DCMF20	20m x 1m



Butyl Self-Adhesive Butyl Membrane

Part Number	Size
BM5	5m x 1m
BM10	10m x 1m

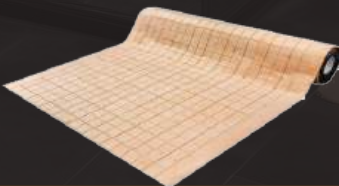

DCPRO Mesh Decoupling Membrane

Part Number	Size
DCPRO5	5m x 1m
DCPRO10	10m x 1m
DCPRO30	30m x 1m

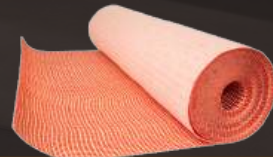

VODA Waterproofing

Sealing Tape

Code	Size
VJT5	5m x 120mm
VJT10	10m x 120mm
VJT50	50m x 120mm



Corners

Code	Size
VWCI	Internal Corner
VWCE	External Corner

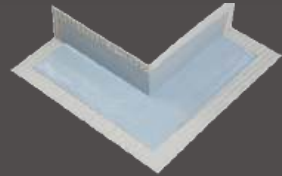

Pipe Collars

Code	Size
VWC25	25-40mm
VWC70	65-120mm
VWC18	18-20mm
VWC1/2	1/2"
VWC15	12-26mm

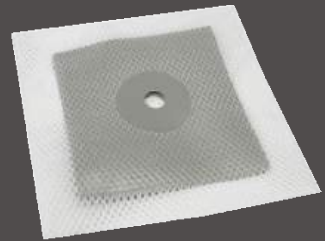

Thermopanel Sealing Tape Kit

Code	Size
VSK001	Thermopanel Waterproof Sealing Tape Set Kit

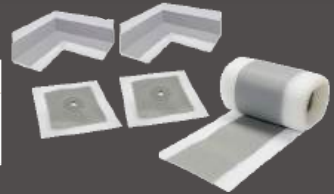

Adhesive / Sealant

Part No.	Size	Description
Thermofix	290ml	Solvent Free Adhesive and Sealant



WPTAPE Waterproofing

Corners

Code	Size
WP-COR-INT	Internal Corner
WP-COR-EXT	External Corner



Sealing Tape

Code	Size
WP-TAPE-5	5m x 120mm Tape
WP-TAPE-10	10m x 120mm Tape



Liner

Code	Size
WP-LINER-5	5m x 1m Liner
WP-LINER-30	30m x 1m Liner



Pipe Collar

Code	Size
WP-COLLAR	Pipe Collar



Wetroom Tanking kits

Code	Size
TANKINGKIT	6.5m ²
TANKINGKITLRG	13m ²



Wetroom Tanking
kit 6.5m²



Large Wetroom
Tanking kit 13m²

ISOTAPE

Sealing Tape

Code	Size
ISOTAPE5	5m x 120mm Tape
ISOTAPE10	10m 120mm Tape
ISOTAPE50	50m 120mm Tape

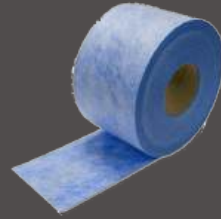

Corners

Code	Size
ISO-COR-INT	Internal Corner
ISO-COR-EXT	External Corner

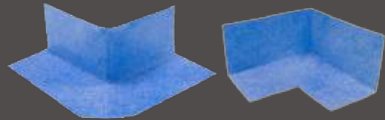

Pipe Collars

Code	Size
ISO-COLLAR-12	12 - 42mm Pipe Collar
ISO-COLLAR-75	75 - 150mm Pipe Collar
ISO-COLLAR-25	25 - 36mm Pipe Collar
ISO-COLLAR-16	Pipe Collar 16mm (120mm Diameter)

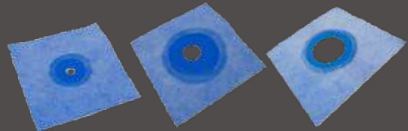

ISOTAPE Tanking Kits

Code	Size
ISO3/1	6.5m ²
ISO3/4	13m ²



Tanking Instructions

VODA Waterproofing, WPTAPE & ISOTAPE

The minimum area to be made waterproof is 1 metre up the height of the wall, and 1 metre into the room from the edge of the wetroom former. The aim is to bind the already waterproof materials, such as the Thermopanel boards with the wetroom former, to create one continuous material to the drain.

1 Check that the suitable substrate is sound, free of any contaminants, and remove any loose material. Any gaps should be filled with a flexible tile adhesive. Dilute the primer 1:1, and apply to the area.

.....

2 Apply the silicone sealant to all gaps/joints in the boards, and where the pipes come through the walls.

.....

3 Apply the liquid film membrane to all corners, the seam between the wetroom former and the surrounding floor/wall, to the area around protruding pipework and any joints on the wall boarding.

.....

4 Embed the fabric membrane corner/s into the liquid film membrane, waterproof pipe collars around any protruding pipework and then apply the tape to the remaining joint areas.

Finally, cover the entire area with the 1-metre-wide fabric membrane, overlapping the taped joints, using the liquid film membrane already applied to bond the two layers together. – For 1m wide membrane sheets

.....

5 Cover the fabric membrane with another layer of the liquid film membrane.

.....

Please allow 12 hours between coats for the liquid film membrane to cure. After this, the area will now be ready to tile.

Butyl Self-Adhesive Waterproofing

Corners

Code	Size
B-INT	Internal Corner
B-EXT	External Corner

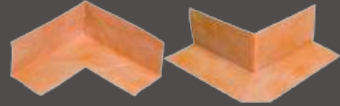

Sealing Tape

Code	Size
BT20	20m X 100mm
BT10	10m x 100mm
BT5	5m X 100mm



Membrane

Code	Size
BM10	10m x 1m Roll
BM5	5m x 1m Roll

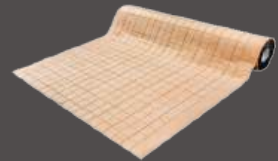

Thermopanel Butyl Tanking Membrane Kits

Code	Size
Butyl5	5m ²
Butyl10	10m ²



Waterproof Joint Tape for Baths & Showers

Code	Size
SBT2	2m
SBT3	3m
SBT4	4m
SBT25	25m

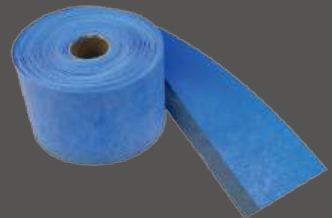

Tanking Instructions

Butyl

The minimum area to be made waterproof is 1 metre up the height of the wall, and 1 metre into the room from the edge of the wetroom former. The aim is to make the entire existing area surrounding the wetroom former one continuous waterproof material to the drain.

1 Check that the suitable substrate is sound, free of any contaminants, and remove any loose material. Any gaps should be filled with a flexible tile adhesive. Dilute the primer 1:1, and apply to the area.

.....

2 Install first the butyl corners, then the butyl tape to all joints between surfaces surrounding the area. Finally, install the 1-metre-wide Butyl Waterproofing membrane, overlapping all the tape/corner/s.

.....

3 Apply the Butyl sealant to all gaps/joints, and where any pipework passes through the membrane.

.....

This area is now ready to tile.

Tanking Diagrams All Products

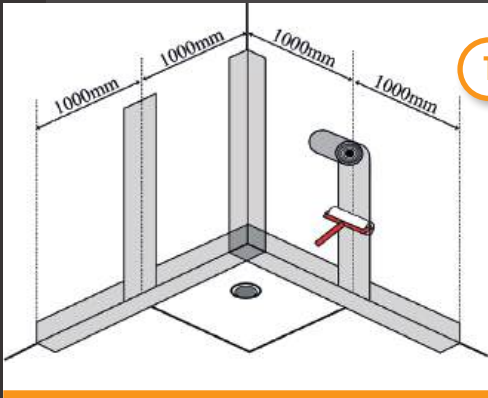

1

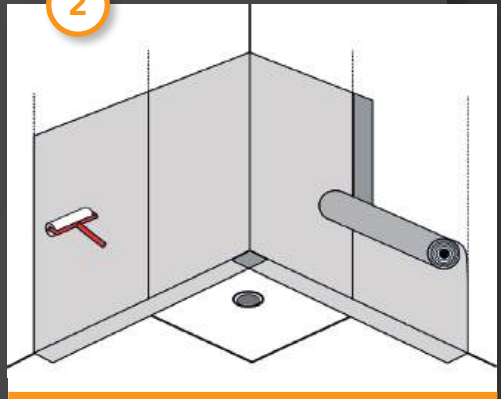

2

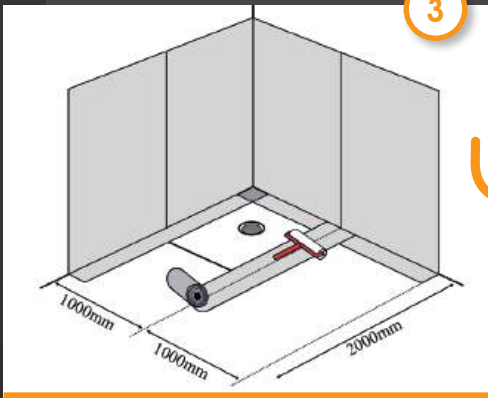

3

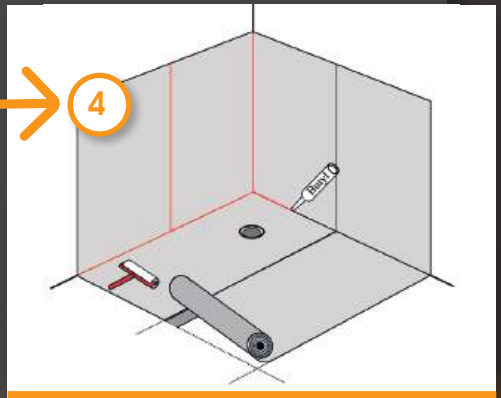

4

Notes

A series of 26 horizontal dotted lines for writing notes.

Notes

A series of horizontal dotted lines for writing notes, spanning the width of the page.



Visit our website for all the
latest offers and updates



www.thermopanel.co.uk

